

Wellenstäbe

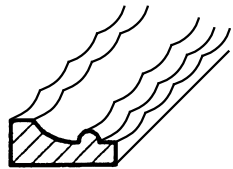

14. 5015. 6

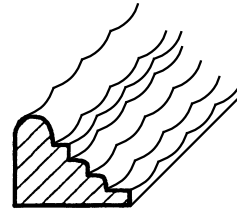

15. 5025. 12

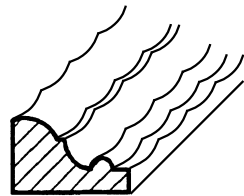

16. 5030. 10

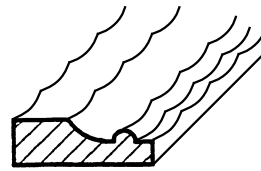

18. 5032. 6

Aufsatzstäbe

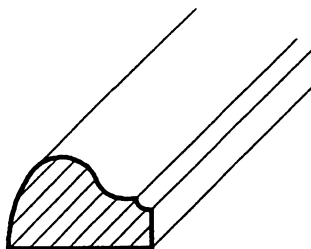

19. 5050. 12

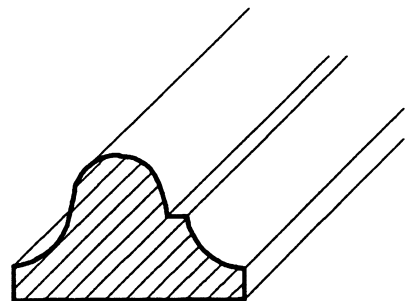

30. 5085. 19

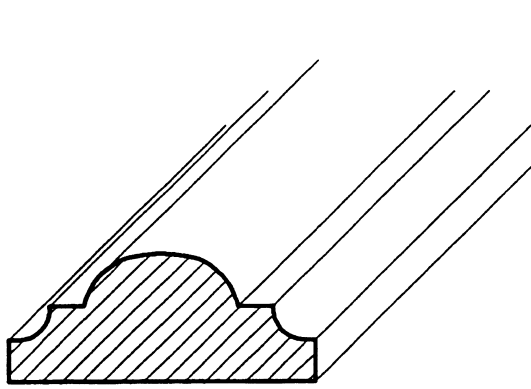

40. 5100. 17

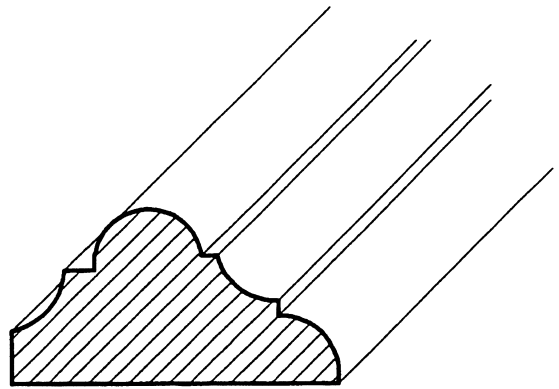

43. 5110. 23

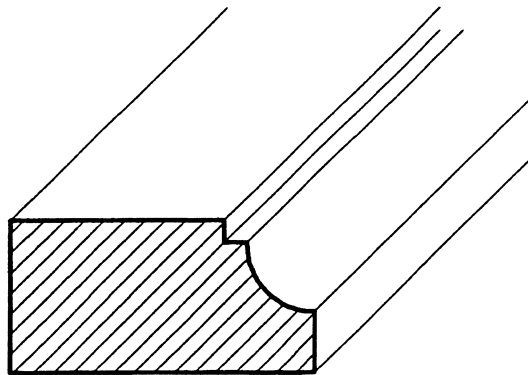

40. 5105. 20

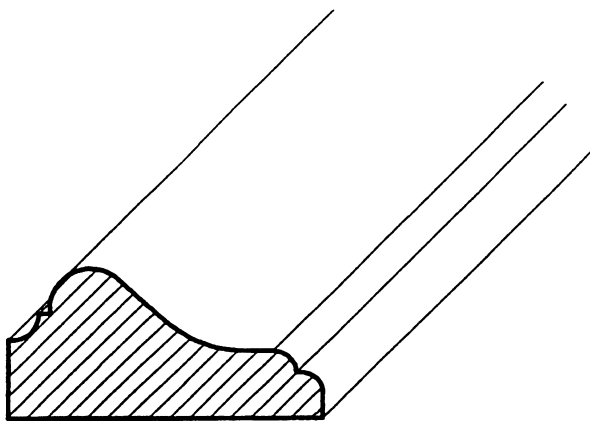

41. 5120. 20

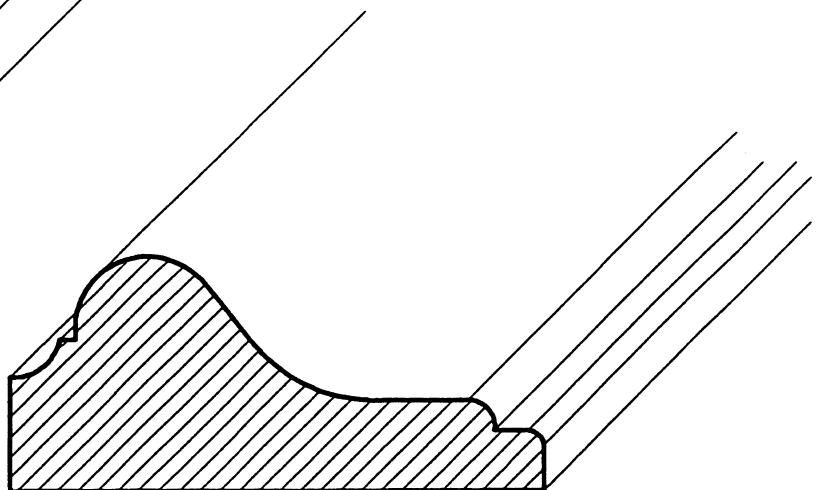

70. 5120. 31

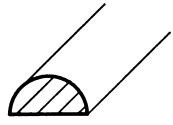

10. 5160. 5
 12. 5160. 6
 15. 5160. 8
 20. 5160. 10
 25. 5160. 13
 30. 5160. 15
 35. 5160. 18
 40. 5160. 20
 50. 5160. 25
 60. 5160. 30
 70. 5160. 35

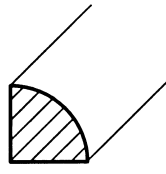

10. 5170. 10
 12. 5170. 12
 15. 5170. 15
 20. 5170. 20
 25. 5170. 25
 30. 5170. 30
 35. 5170. 35

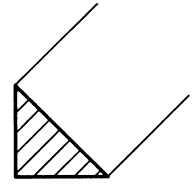

12. 5180. 12
 15. 5180. 15
 20. 5180. 20
 25. 5180. 25
 30. 5180. 30
 50. 5180. 50
 60. 5180. 60

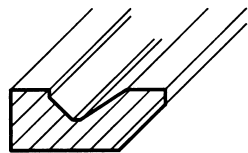

8. 5210. 20

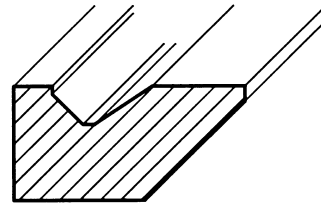

15. 5210. 30 BU

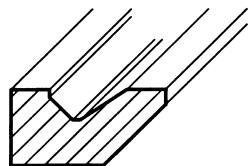

10. 5210. 20

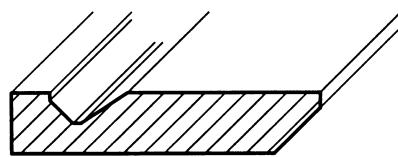

8. 5210. 40

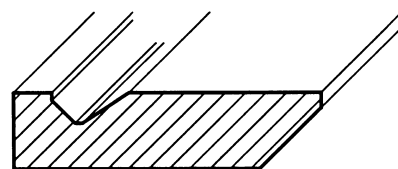

10. 5210. 40

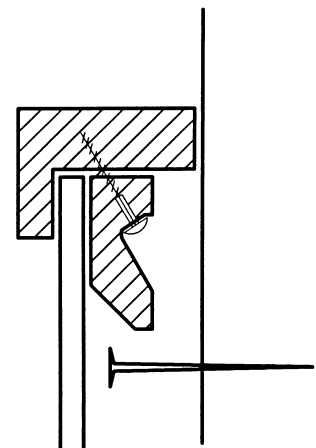

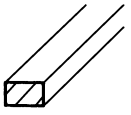

3. 5150. 5
 4. 5150. 4
 4. 5150. 6
 4. 5150. 8
 4. 5150. 10
 4. 5150. 12
 5. 5150. 5
 5. 5150. 8
 5. 5150. 10
 5. 5150. 15
 5. 5150. 20
 5. 5150. 30
 5. 5150. 40
 5. 5150. 50
 5. 5150. 55

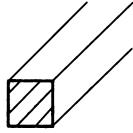

6. 5150. 6
 6. 5150. 8
 6. 5150. 10
 6. 5150. 15
 6. 5150. 20
 7. 5150. 10
 7. 5150. 12
 7. 5150. 15
 7. 5150. 20
 7. 5150. 30
 7. 5150. 35
 8. 5150. 8
 8. 5150. 15

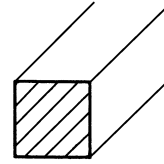

10. 5150. 10
 10. 5150. 12
 10. 5150. 15
 10. 5150. 20
 10. 5150. 25
 10. 5150. 30
 10. 5150. 35
 10. 5150. 40
 10. 5150. 50
 10. 5150. 60
 10. 5150. 70
 10. 5150. 80
 12. 5150. 25
 12. 5150. 30
 12. 5150. 40
 12. 5150. 50

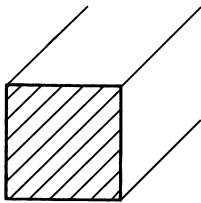

15. 5150. 15
 15. 5150. 20
 15. 5150. 25
 15. 5150. 30
 15. 5150. 40
 15. 5150. 50
 15. 5150. 60
 15. 5150. 70
 15. 5150. 85
 15. 5150. 90
 15. 5150. 100
 15. 5150. 125

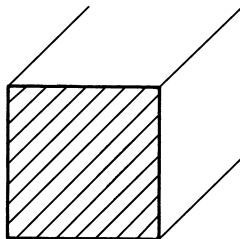

20. 5150. 20
 20. 5150. 25
 20. 5150. 30
 20. 5150. 40
 20. 5150. 50
 20. 5150. 60
 20. 5150. 70
 20. 5150. 80
 20. 5150. 90
 20. 5150. 100

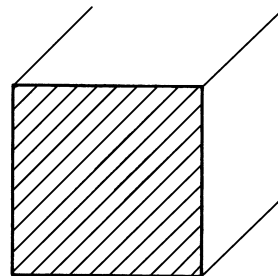

25. 5150. 25
 25. 5150. 35
 25. 5150. 45
 30. 5150. 40
 30. 5150. 50
 30. 5150. 60
 40. 5150. 40

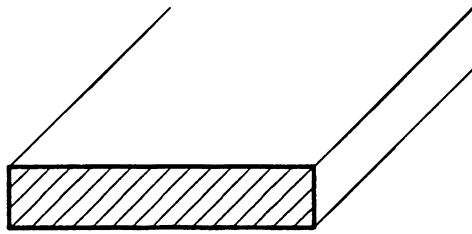

8. 5150. 40

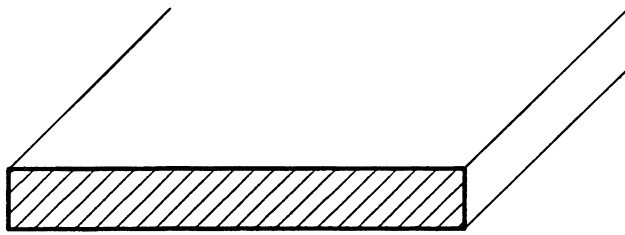

8. 5150. 60

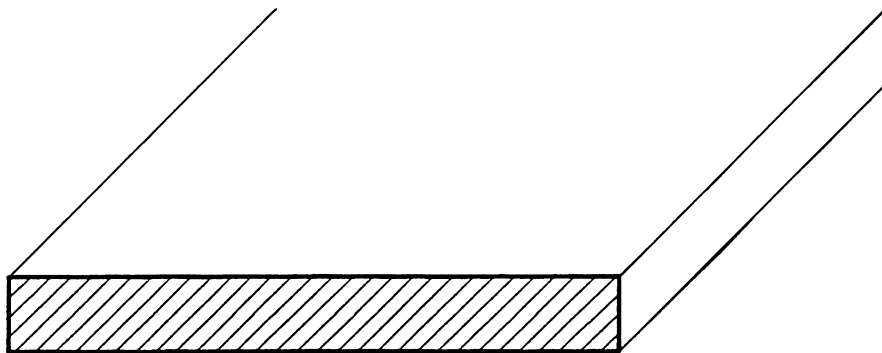

10. 5150. 80

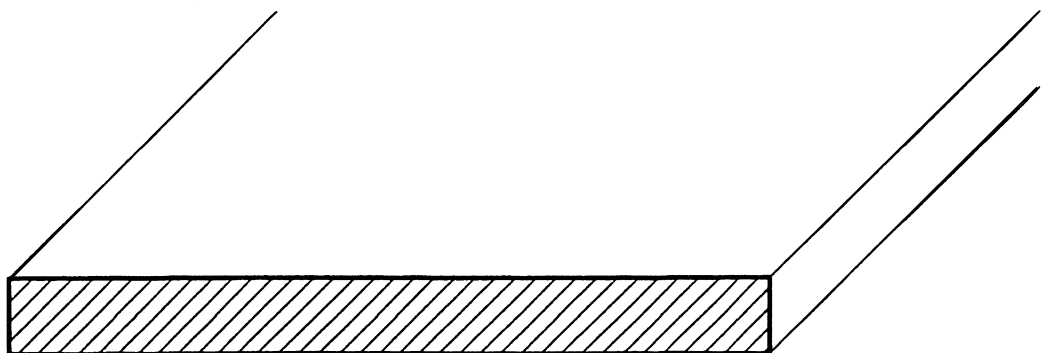

10. 5150. 100

Wellenstäbe

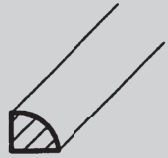

6. 5000. 5

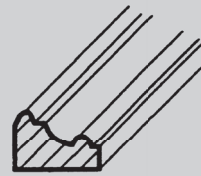

11. 5005. 8

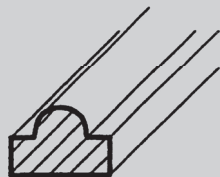

13. 5010. 9

Schlangenstab

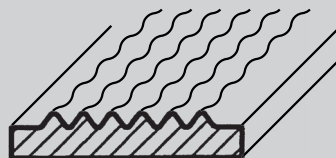

30. 5040. 6

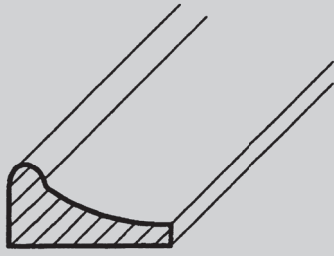

21. 5060. 11

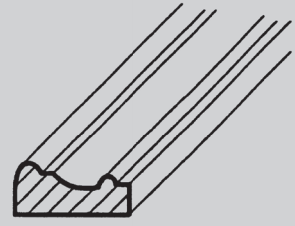

15. 5020. 7

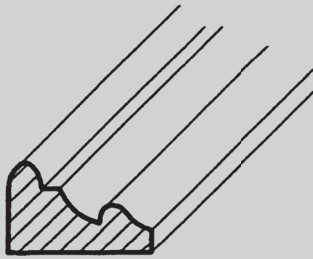

19. 5045. 12

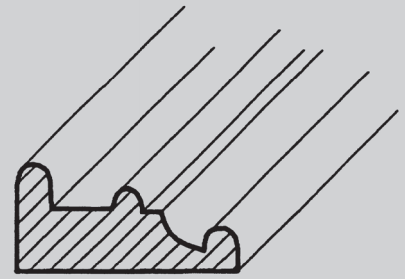

29. 5080. 14

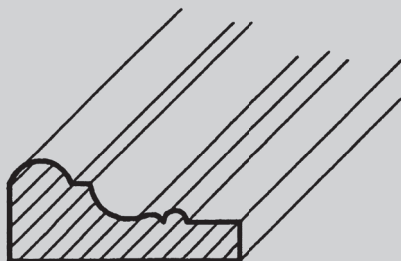

30. 5035. 13

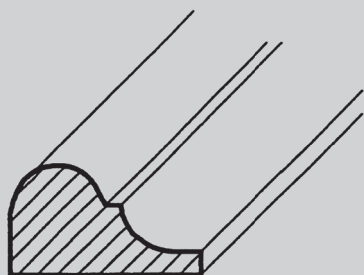

25. 5070. 15

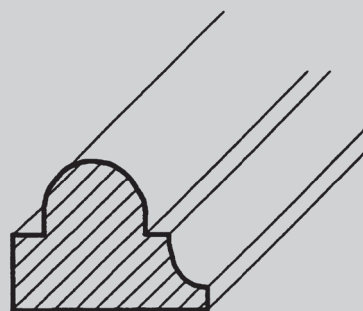

25. 5075. 20

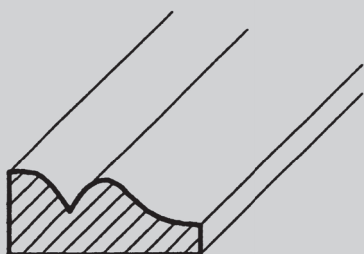

25. 5065. 11

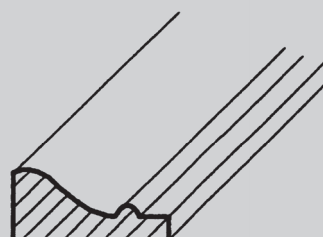

20. 5055. 9

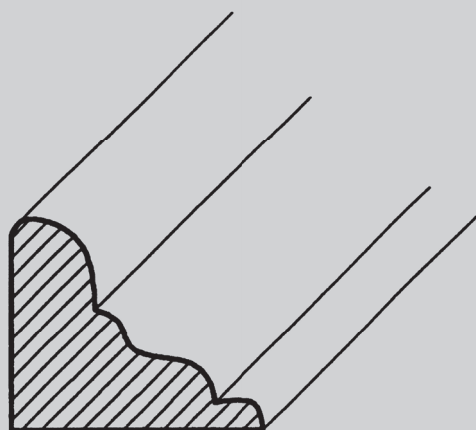

33. 5090. 28

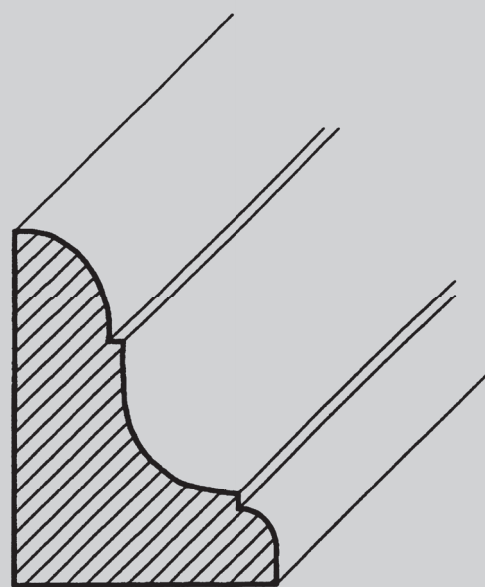

34. 5095. 47